



**ALPHA DISC LTD**

---

# PRODUCT RANGE

---



## COMPANY PROFILE

The company was originally conceived in 1982 as a floppy disc drive repair facility, designed to meet the growing demand for a rapid and reliable service on this key item of peripheral equipment.

The bringing together of a number of engineers, highly experienced in this relatively new field, sparked off a rapid expansion of our business, such that now, ALPHA DISC can rightly claim to be the largest independent repair company for floppy disc drives in the UK.

With a first-class support facility it was inevitable that ALPHA DISC should expand into floppy disc drives sales:

### ALPHA DISC FOR SALES

With the benefit of incisive product evaluation we are able to select only those products of the highest quality and value for money. Our international trading network enables us to purchase these products world-wide and offer them at highly competitive prices.

Our aim is to offer you, our customer, a total solution to your floppy disc drive requirements.

#### PRE-SALES CONSULTATION

#### SALE OF DISC DRIVES AND DRIVE SUB-SYSTEMS

#### COMPREHENSIVE AFTER-SALES SUPPORT

#### SERVICE ONLY SALES, ON A WIDE RANGE OF MANUFACTURED DISC DRIVES AND SPARES.

### ALPHA DISC FOR SERVICE

It takes a certain kind of expertise to service floppy disc drives. The requirement is for an interface of the skills of mechanical and electronic engineering, and experience is crucial.

At ALPHA DISC, our engineers have been repairing disc drives for as long as drives have been on the market, and it shows!

Our service takes the form of an exacting three-stage operation.

#### 1) DIAGNOSTIC TESTING:

Using the latest equipment and techniques to test a wide variety of parameters.

#### 2) REPAIR AND ADJUSTMENT:

All units are checked and set against manufacturers' standards.

#### 3) SYSTEM TESTING:

Every new and repaired drive is individually computer tested to read and write in high density data formats.

*We are the company the other drive distributors come to for service.*

*Remember, sales or service, speak to the experts. Speak to ALPHA DISC LTD.*

## CANON MDD 210

This is a 40TK double sided 2/3 height disc drive compatible with the BBC micro which has a DFS fitted, single or double density.

### TECHNICAL SPEC

40TK D/S  
200K (400K double density)  
6ms track to track  
Direct drive DC motor  
Head load solenoid

All drives come complete with utilities disc, manual and cables to run on the BBC micro.

**Single 210**

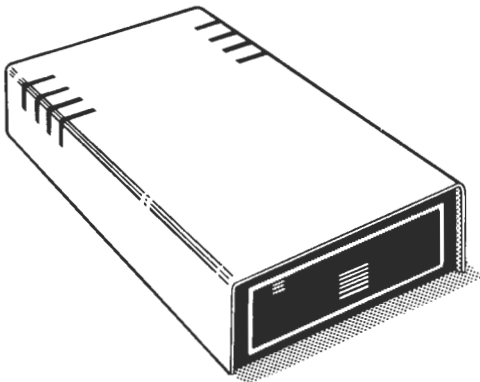

**Dual 210 with PSU**

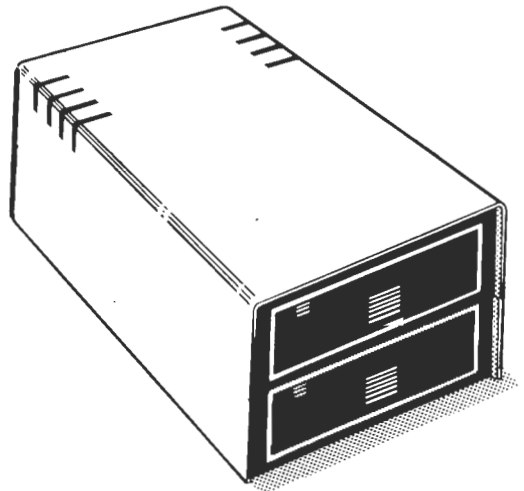

## CANON MDD 220

This is an 80TK double sided 2/3 height disc drive compatible with the BBC which has a DFS fitted (single or double density). It is capable of being switched between 40 & 80 track and is compatible with discs generated on other 40TK disc drives. It has a dual colour LED, green = 40, red = 80, which is permanently on in half brilliance and full brilliance when the drive is selected. This drive also has the unique 40/80TK switch that enables the user to switch between the 40 and 80 track modes without having to reset the drive.

## TECHNICAL SPEC

40/80 track switchable  
400K (800K double density)  
6ms track to trace in 40 track mode  
3ms track to trace in 80 track mode  
Direct drive DC motor  
Head load solenoid  
Dual colour LED

All drives are supplied with utilities disc, manual and cables to run on the BBC micro.

**Single 220**

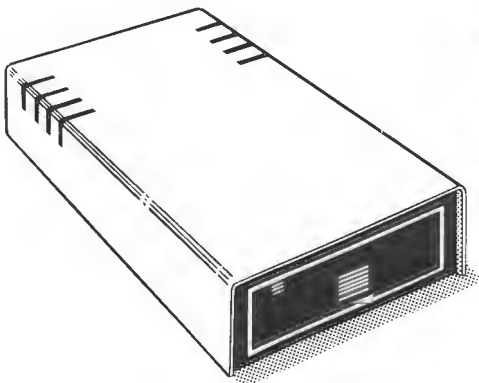

**Dual 220 with PSU**

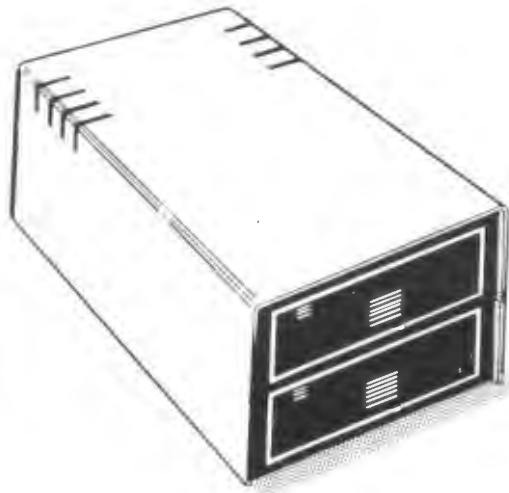

## CANON MDD 211A

This is a 40TK double sided super slim 1/3 height disc drive compatible with the BBC micro that has a DFS fitted, single or double density.

### TECHNICAL SPEC

40TK D/S  
200K (400K double density)  
6ms track to track  
Direct drive DC motor  
Head load solenoid  
Push button disc eject

All drives are supplied with utilities disc, manual and cables to run on the BBC micro.

**Single 211A**

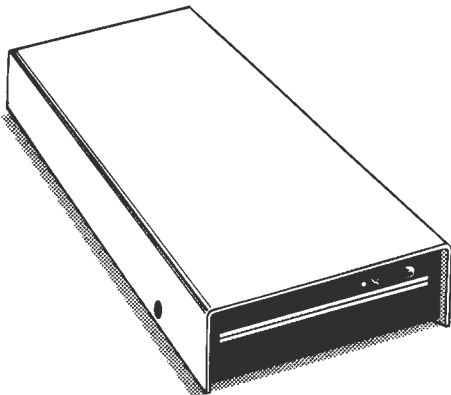

**Dual 211A with PSU**

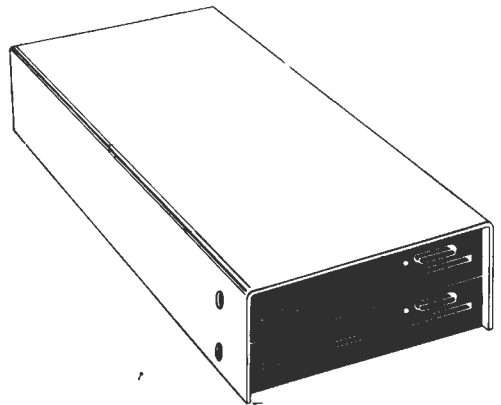

## CANON MDD 221A

This is a 40/80TK switchable double sided 1/3 height disc drive compatible with the BBC micro that has a DFS fitted (single or double density). It has a dual colour LED, green = 40, red = 80, which is permanently on in half brilliance when the drive is selected. This drive also has the unique 40/80TK switch that enables the user to switch between the 40 and 80 track modes without having to reset the drive.

### TECHNICAL SPEC

40/80 track switchable  
400K (800K double density)  
6ms track to trace access in 40 track mode  
3ms track to trace access in 80 track mode  
Direct drive DC motor  
Head load solenoid  
Dual colour LED  
Push button auto disk eject

All drives are supplied with utilities disc, manual and cables to run on the BBC micro.

**Single 221A**

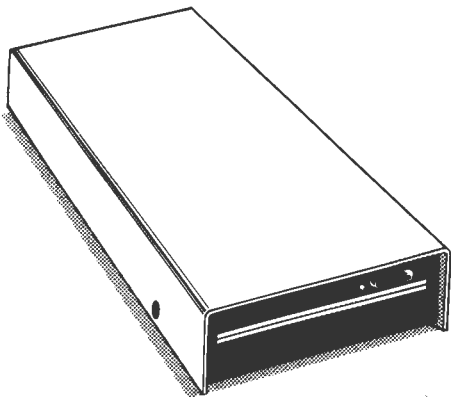

**Dual 221A with PSU**

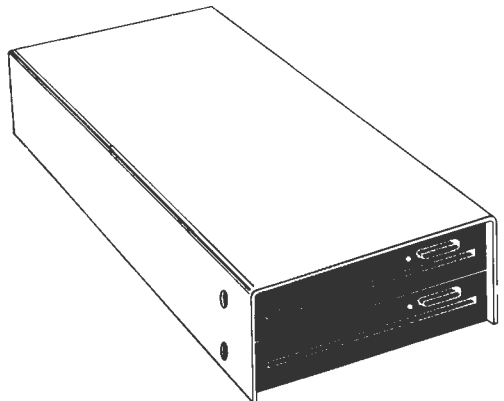

## VECTOR 1

*The ultimate tape to disk utility*

Vector 1 allows you to transfer almost all your tape software to disk. Unlike others, you only need to buy 1 copy of Vector 1 since it transfers tapes to specially formatted program discs. This is easily the most powerful tape to disk utility available.

## VECTOR 2

*Disc to disk utility*

Vector 2 allows you to make backup copies of all your valuable disk software. It is the most advanced utility of its kind available. It is a condition of sale that neither of these products are used for infringement of the copyright.

1.2 versions available.

## DISCUS

Test utility for testing your own disc drive, at regular intervals to avoid the dreaded flop of your floppy. Menu driven, easy to use, 40 or 80 track versions.

TESTS: Motor speed, read/write, steptest, alignment test,\*, step & read/write test, read only test.

£8.00 inc £7.00 if purchased with disc drive.

\*This test requires an oscilloscope & alignment disc.

## EPROMS

*Quality eproms by 'Hitachi'*

2764--250 NS  
27128--250 NS



## VECTOR 1

*The ultimate tape to disk utility*

Vector 1 allows you to transfer almost all your tape software to disk. Unlike others, you only need to buy 1 copy of Vector 1 since it transfers tapes to specially formatted program discs. This is easily the most powerful tape to disk utility available.

## VECTOR 2

*Disc to disk utility*

Vector 2 allows you to make backup copies of all your valuable disk software. It is the most advanced utility of its kind available. It is a condition of sale that neither of these products are used for infringement of the copyright.

1.2 versions available.

## DISCUS

Test utility for testing your own disc drive, at regular intervals to avoid the dreaded flop of your floppy. Menu driven, easy to use, 40 or 80 track versions.

TESTS: Motor speed, read/write, steptest, alignment test,\*, step & read/write test, read only test.

£8.00 inc £7.00 if purchased with disc drive.

\*This test requires an oscilloscope & alignment disc.

## EPROMS

*Quality eproms by 'Hitachi'*

2764--250 NS

27128--250 NS

## DIAGRAM

A program which allows you to store very large diagrams—up to 39 mode 0 screens—and view or edit them by SCROLLING the computer screen around over any part of the diagram.

### **Features**

Draw diagrams, schematics, plans etc, in any aspect ratio, e.g. 10\*3, 2\*12 screens. Access any part of the diagram rapidly by entering an index name, e.g. TR6, R5 etc, to display a specific section of the diagram, and then scroll around to any other part of the diagram using the cursor keys.

Up to 128 Icons may be predefined for each diagram e.g. transistors, resistors etc, in full mode 0 definition, up to 32 pixels horizontally by 24 vertically.

Hard copy printouts in varying print sizes up to 9 mode 0 screens on an A4 size sheet, compatible with most dot matrix printers.

Many other features including, selectable display colours, comprehensive line drawing facilities, TAB settings, etc.

Disc contains sample diagrams and two versions of the program, one of which will work from a 16k sideways RAM.

Comprehensive instruction manual.





# SPECIAL EXHIBITION PRICES

## DISC DRIVES

<b>CANON MDD 210 40TK DS 200K (400K DOUBLE DENSITY)</b>	
SINGLE NO PSU	£75.00
SINGLE WITH PSU	£99.00
DUAL WITH PSU	£179.00

<b>CANON MDD 220 80TK DS 400K (800K DOUBLE DENSITY)</b>	
SINGLE NO PSU	£99.00
SINGLE WITH PSU	£129.00
DUAL WITH PSU	£229.00

<b>CANON MDD 211A 40TK DS 200K (400K DOUBLE DENSITY)</b>	
SINGLE NO PSU	£89.00
— — — —	—
DUAL WITH PSU	£219

<b>CANON MDD 221A 80TK DS 400K (800K DOUBLE DENSITY)</b>	
SINGLE NO PSU	£149.00
— — — —	—
DUAL WITH PSU	£314.00

## SOFTWARE

VECTOR 1	£15.00
VECTOR 2	£15.00
VECTOR 1 & 2	£28.00

DIAGRAM £25.00

DISCUS £7.00

## SUNDRIES

FUJI 40TK DS DISCS	£22.50
FUJI 80TK DS DISCS	£26.60

EPROMS 2764—250 NS	£2.90
27128—250 NS	£4.99

DISC WALLETS £2.00

*All these prices include VAT*